

MCD

Drape Offering
Interventional Cardiology
Interventional Radiology



FEMORAL
ACCESS

ANTIMICROBIAL
PACER

RADIAL ACCESS



MCD Agents work behind the scenes, keeping patients safe since 1984.

- Creating sterile fields
- Engineered for better sterile performance
- **ACTI-Gard**® antimicrobial reduces levels of microorganisms associated with post-op infections
- **ANGIO-Shield**® level 4 barrier protection prevents strike-through contamination



Made in USA Exclusively

- FDA Registered
- ISO 13485:2003 facility

More Options



- Cost effective automation
- Customer specified product designs
- Private label options
- Converting capabilities

Why buy MCD **ACTI-Gard**[®] antimicrobial pacer drapes?

- Effectively reduces the levels of microorganisms associated with post-operative infection
- Cost-effective: available bulk nonsterile for use in procedural packs/trays
- Antimicrobial: revolutionary stable iodine complex
 - Nonirritating and nonsensitizing

Log Count of Selected Microorganisms vs Time *ACTI-Gard*[®] and Ioban[™] 2 on seeded Pig and Human Skin

■ Control ■ Ioban 2 ■ ACTI-Gard

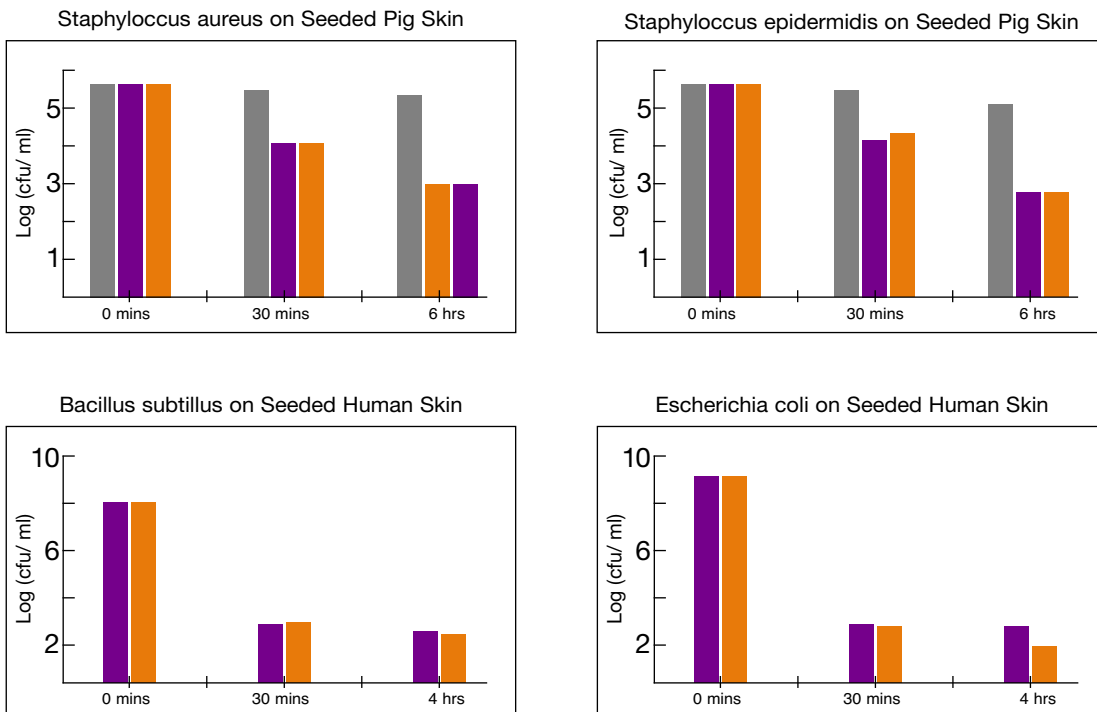

Why buy MCD **ANGIO-Shield**[®] with level 4* barrier protection?

- Superior aperture construction
- Proprietary to MCD

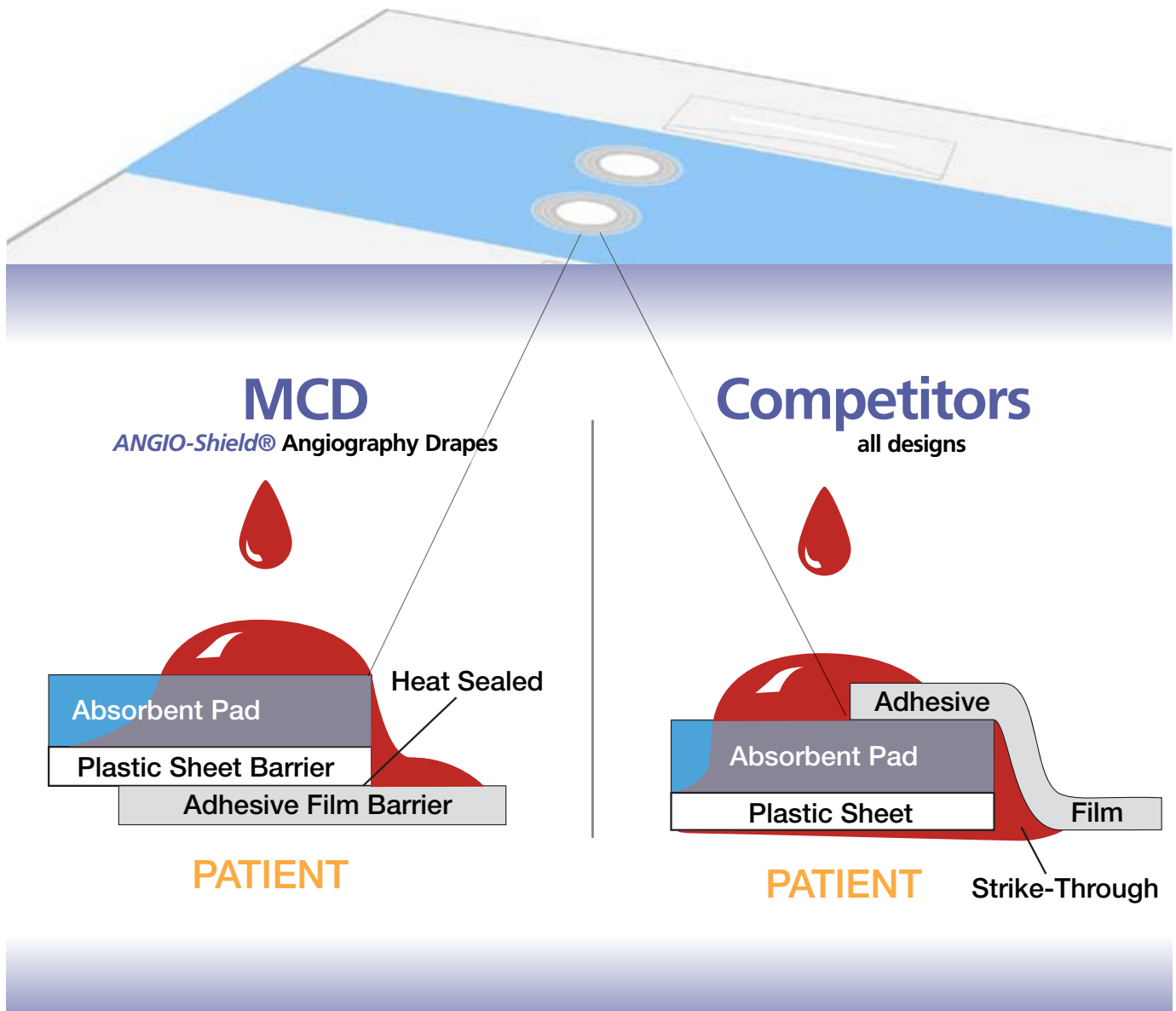

*AAMI PB70:2003 Liquid barrier performance and classification

INDEX BY DRAPE STYLE

Radial/Femoral Angiography Drapes

D2344	Lulu Radial/Femoral Angiography Sheet	1
D2355	Orlando Radial/Femoral Angiography Sheet	1
D2366	Lulu Radial/Femoral Angiography Sheet	1
C2377*	Radial/Femoral Angiography Sheet	1
D2388	Radial/Femoral Angiography Sheet	1
D2399	Moveable Radial/Femoral Angiography Sheet	1
C2411*	Multiaccess IR Sheet	2
D2422	Radial/Brachial Sleeve	2
C2433*	Radial/Femoral Angiography Sheet	2
C2444*	Moveable Multiaccess IR Sheet	2

Round Aperture Angiography Drapes

D1395	ANGIO-Shield® Absorbent Angio Sheet	3
D1495	ANGIO-Shield® Absorbent Angio Sheet	3
D1595	ANGIO-Shield® Absorbent Angio Sheet	3
D2284C	ANGIO-Shield® Absorbent Angio Sheet	3
D2288C	ANGIO-Shield® Absorbent Angio Sheet	3
C2302*	Absorbent Angio Sheet	3
C2339*	Pediatric Angio Sheet	4

Oval Aperture Angiography Drapes

D1093	Neonatal Absorbent Angio Sheet	4
D1191	ANGIO-Shield® Absorbent Angio Sheet	4
D1195	ANGIO-Shield® Absorbent Angio Sheet	4
D1295	ANGIO-Shield® Absorbent Angio Sheet	5
D1391	ANGIO-Shield® Absorbent Angio Sheet	5
D2244	ANGIO-Shield® Absorbent Angio Sheet	5
D2252	ANGIO-Shield® Absorbent Angio Sheet	5
D2265C	ANGIO-Shield® Absorbent Angio Sheet	5
D2286	ANGIO-Shield® Absorbent Angio Sheet	5

Antimicrobial Pacer Drapes

D6614C	ACTI-Gard® Antimicrobial Pacer Sheet	7
D6621	ACTI-Gard® Antimicrobial Fluoroscope Procedure Sheet	7
D6622	ACTI-Gard® Antimicrobial Pacer Sheet	7
D6625C	ACTI-Gard® Antimicrobial Fluoroscope Procedure Sheet	7
D6628C	ACTI-Gard® Antimicrobial Fluoroscope Procedure Sheet	7
D6643C	ACTI-Gard® Antimicrobial Fluoroscope Procedure Sheet	7
D6663	ACTI-Gard® Antimicrobial Fluoroscope Procedure Sheet	8
D6673C	ACTI-Gard® Antimicrobial Fluoroscope Procedure Sheet	8

D2292C	ANGIO-Shield® Absorbent Angio Sheet	6
D2294C	ANGIO-Shield® Absorbent Angio Sheet	6
D2298C	ANGIO-Shield® Absorbent Angio Sheet	6
C2308*	ANGIO-Shield® Absorbent Angio Sheet	6
C2345*	ANGIO-Shield® Absorbent Angio Sheet	6

Single Aperture Drapes

D2224	ANGIO-Shield® Special Procedure Drape	10
D2264	Fistula Drape	10
D2318C	Full Body Fistula Sheet	10
C2242*	Teen Absorbent Angio Sheet	10
C2289*	Special Procedure Drape	10
C2290*	Fistula Drape	10
C2299*	Small Aperture Drape	11

Subclavian/Jugular/Biliary Drapes

D2260	Subclavian Drape	11
D2315C	Jugular Sheet	11
C2332*	Jugular Sheet	11
C2349*	Subclavian/Biliary Sheet	12

Central Line Drapes

D2317C	Central Line Sheet	12
D2342	PICC Line Sheet	12
C2324*	Central Line Drape	12
C2346*	Central Line Sheet	13
C2351*	PICC Line Drape	13

Accessories

D1012	Fluoroscope Cover	13
D1013	C-Arm Cover	13
C2326*	Irrigation Pouch	13

NUMERICAL INDEX		14
-----------------	--	----

Pacer Drapes

D2221	Fluoroscope Procedure Sheet	8
D2310C	Pacemaker Sheet	8
C2304*	Pacemaker Sheet	8
C2311*	Fluoroscope Procedure Sheet	9
C2319*	Pacemaker Sheet	9
C2325*	Pacemaker Sheet	9
C2335*	Pacemaker Sheet	9

*NOTE: "C" Product codes require a 4-6 week lead time.

Radial/Femoral Angiography Drapes

Lulu Radial/Femoral Angio Sheet

D2344

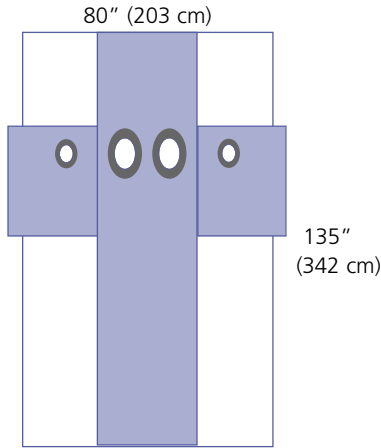

Radial Apertures
2.5" x 3.5" (6 cm x 9 cm)
Femoral Apertures
3.5" x 4.5" (8 cm x 11 cm)

Sterile: 20/bx
Nonsterile: 30/cs

Radial/Femoral Angio Sheet

C2377*

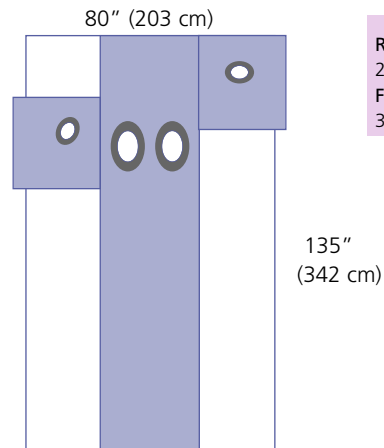

Radial Apertures
2.5" x 3.5" (6 cm x 9 cm)
Femoral Apertures
3.5" x 4.5" (8 cm x 11 cm)

Sterile: 20/bx
Nonsterile: 30/cs

Orlando Radial/Femoral Angio Sheet

D2355

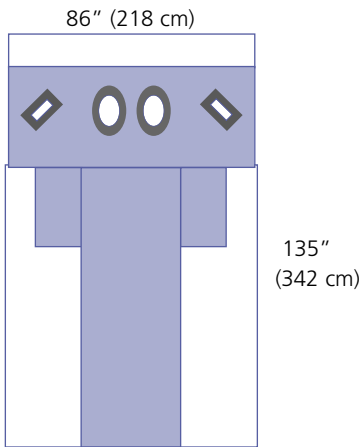

Radial Apertures
2.5" x 6" (6 cm x 15 cm)
Femoral Apertures
3.5" x 4.5" (8 cm x 11 cm)

Sterile: 20/bx
Nonsterile: 30/cs

Radial/Femoral Angio Sheet

D2388

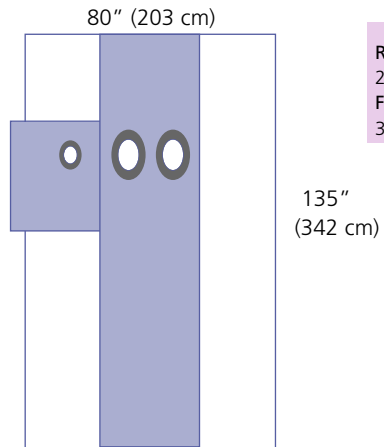

Radial Aperture
2.5" x 3.5" (6 cm x 9 cm)
Femoral Apertures
3.5" x 4.5" (8 cm x 11 cm)

Sterile: 20/bx
Nonsterile: 30/cs

Lulu Radial/Femoral Angio Sheet

D2366

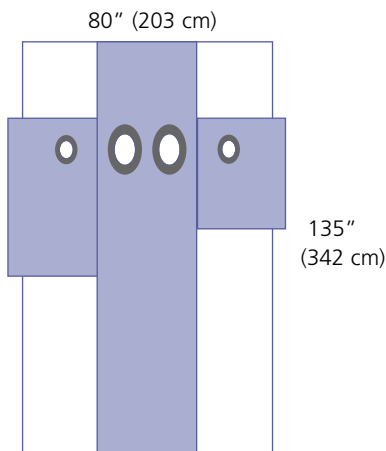

Radial Apertures
2.5" x 3.5" (6 cm x 9 cm)
Femoral Apertures
3.5" x 4.5" (8 cm x 11 cm)

Sterile: 20/bx
Nonsterile: 30/cs

Moveable Radial/Femoral Angio Sheet

D2399

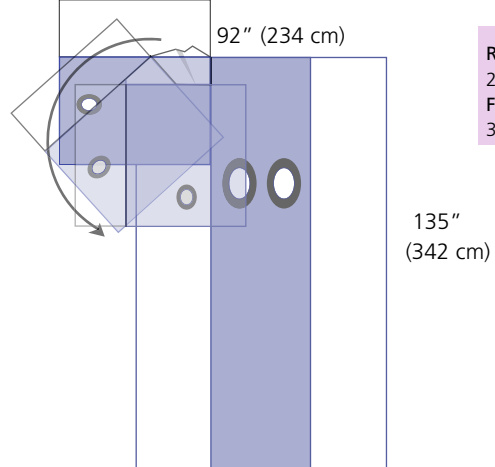

Radial Aperture
2.5" x 3.5" (6 cm x 9 cm)
Femoral Apertures
3.5" x 4.5" (8 cm x 11 cm)

Sterile: 20/bx
Nonsterile: 30/cs

PRODUCT KEY:

- Adhesive
- Clear Film
- Nonwoven Fabric
- Absorbent Reinforcement
- Foam
- Antimicrobial Adhesive

Radial/Femoral Angiography Drapes

Multiaccess IR Sheet

C2411*

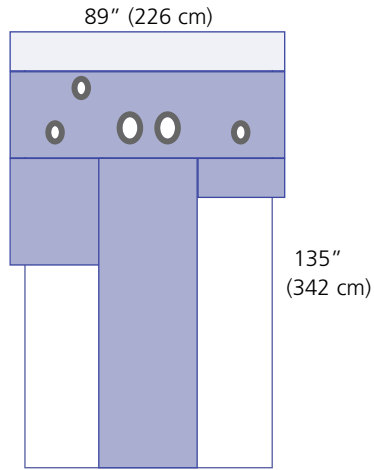

Radial Apertures
2.5" x 3.5"
(6 cm x 9 cm)
Brachial Aperture
2.5" x 3.5"
(6 cm x 9 cm)
Femoral Apertures
3.5" x 4.5"
(8 cm x 11 cm)

Sterile: 20/bx
Nonsterile: 30/cs

Moveable Multiaccess IR Sheet

C2444*

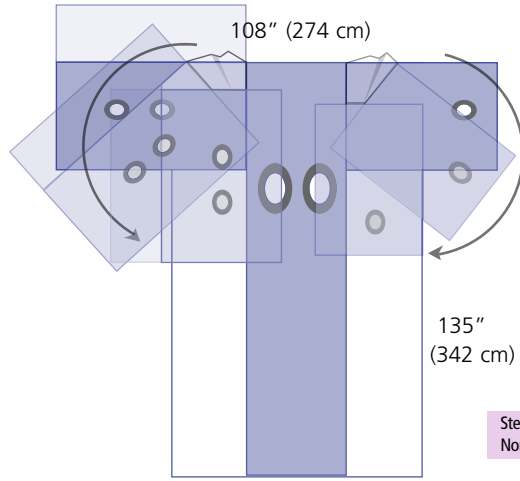

Radial Apertures
2.5" x 3.5"
(6 cm x 9 cm)
Brachial Aperture
2.5" x 3.5"
(6 cm x 9 cm)
Femoral Apertures
3.5" x 4.5"
(8 cm x 11 cm)

Sterile: 20/bx
Nonsterile: 30/cs

Radial/Brachial Sleeve

D2422

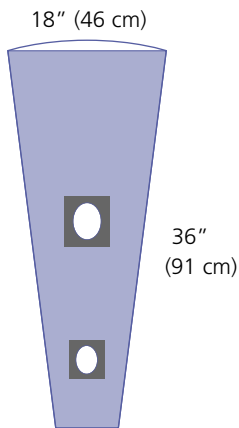

Radial Aperture
2" x 3" (5 cm x 7.6 cm)
Femoral Aperture
2.5" x 3.5" (6 cm x 9 cm)

Sterile: 20/bx
Nonsterile: 50/cs

Radial/Femoral Angio Sheet

C2433*

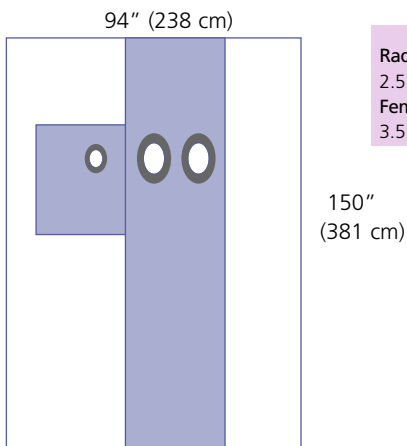

Radial Aperture
2.5" x 3.5" (6 cm x 9 cm)
Femoral Apertures
3.5" x 4.5" (8 cm x 11 cm)

Sterile: 20/bx
Nonsterile: 30/cs

PRODUCT KEY:

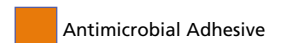
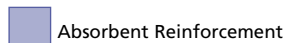

Round Aperture Angiography Drapes

ANGIO-Shield® Absorbent Angio Sheet D1395

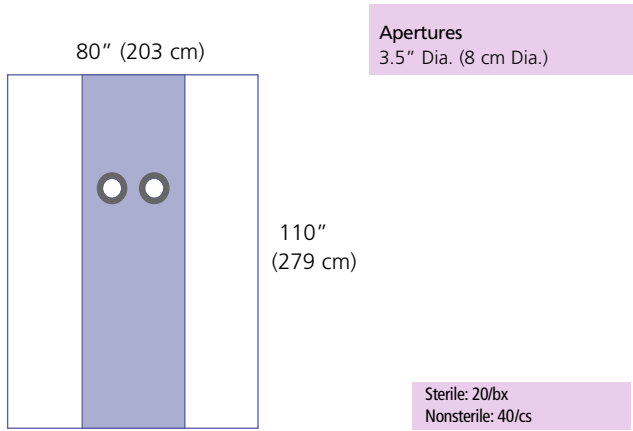

ANGIO-Shield® Absorbent Angio Sheet D2284C

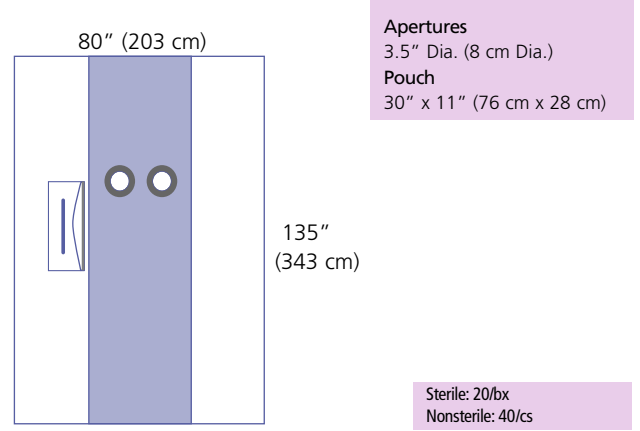

ANGIO-Shield® Absorbent Angio Sheet D1495

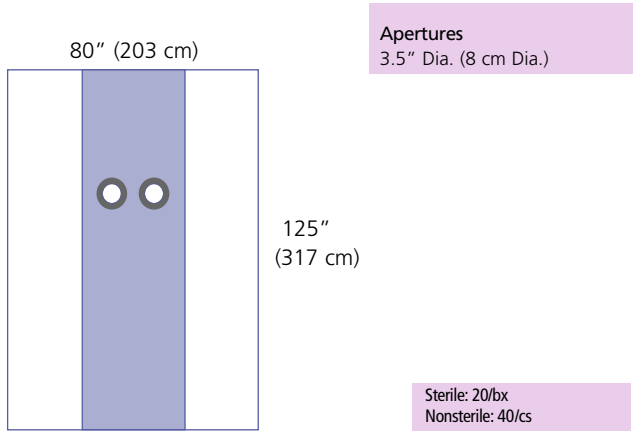

ANGIO-Shield® Absorbent Angio Sheet D2288C

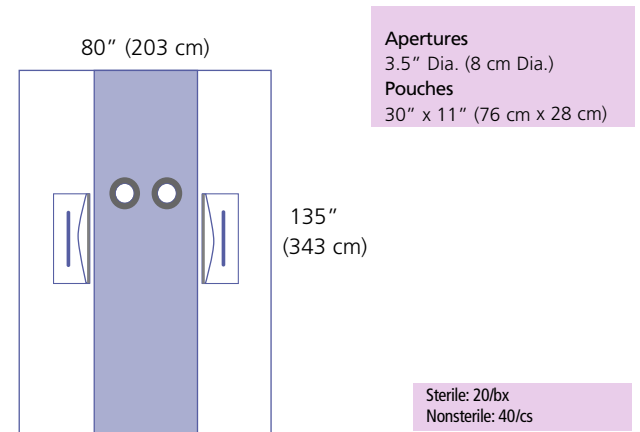



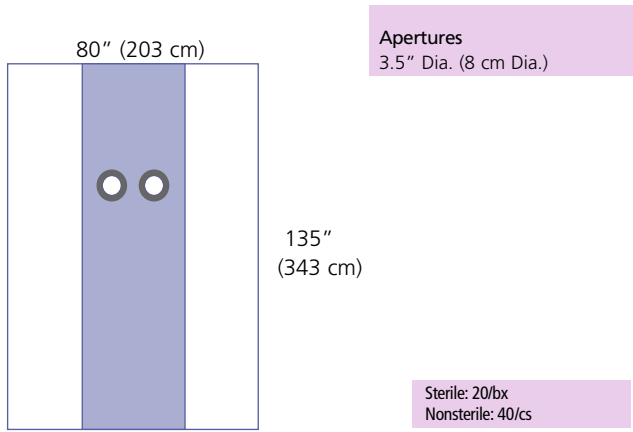

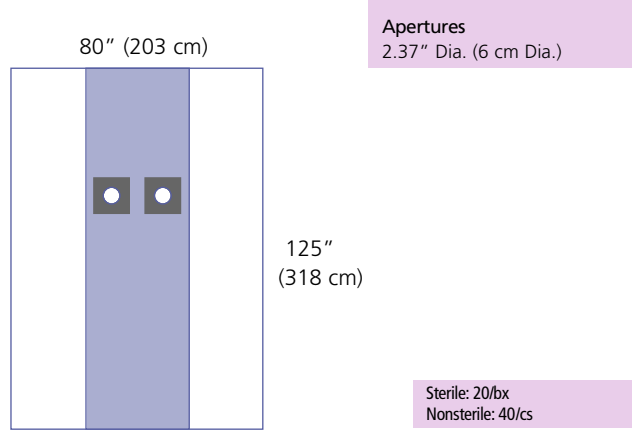

ANGIO-Shield® Absorbent Angio Sheet D1595



Absorbent Angio Sheet C2302*



PRODUCT KEY:  Adhesive  Clear Film  Nonwoven Fabric  Absorbent Reinforcement  Foam  Antimicrobial Adhesive

*NOTE: "C" Product codes require a 4-6 week lead time.

Round Aperture Angiography Drapes

Pediatric Angio Sheet

C2339*

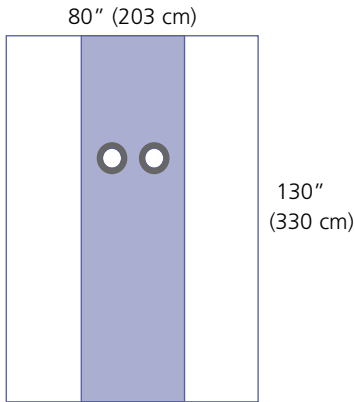

Apertures
3.5" Dia. (8 cm Dia.)

Sterile: 20/bx
Nonsterile: 40/cs

Oval Aperture Angiography Drapes

Neonatal Angio Sheet

D1093

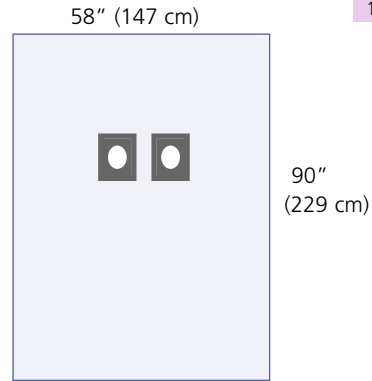

Apertures
1.5" x 2" (3 cm x 5 cm)

Sterile: 20/bx
Nonsterile: 40/cs

ANGIO-Shield® Absorbent Angio Sheet

D1191

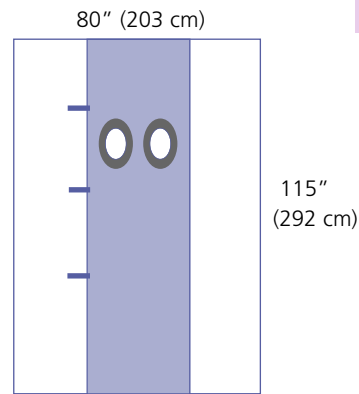

Apertures
3.5" x 4.5" (8 cm x 11 cm)

Sterile: 20/bx
Nonsterile: 40/cs

ANGIO-Shield® Absorbent Angio Sheet

D1195

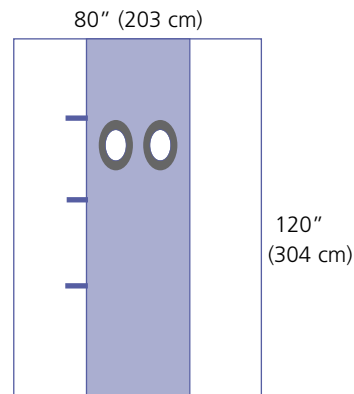

Apertures
3.5" x 4.5" (8 cm x 11 cm)
Identical to D2252
except folded larger.
Fold size
12" x 17" (30 cm x 43 cm)

Sterile: 20/bx
Nonsterile: 40/cs

PRODUCT KEY:

- Adhesive
- Clear Film
- Nonwoven Fabric
- Absorbent Reinforcement
- Foam
- Antimicrobial Adhesive

Oval Aperture Angiography Drapes

ANGIO-Shield® Absorbent Angio Sheet D1295

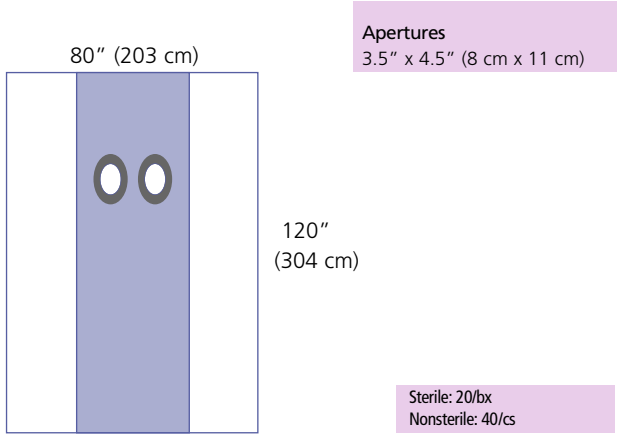

ANGIO-Shield® Absorbent Angio Sheet D2252

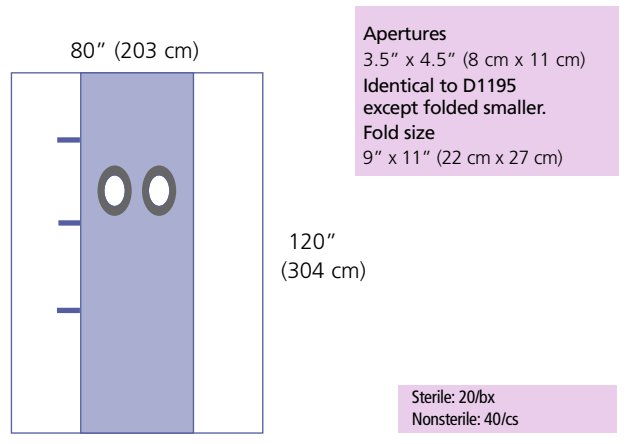

ANGIO-Shield® Absorbent Angio Sheet D1391

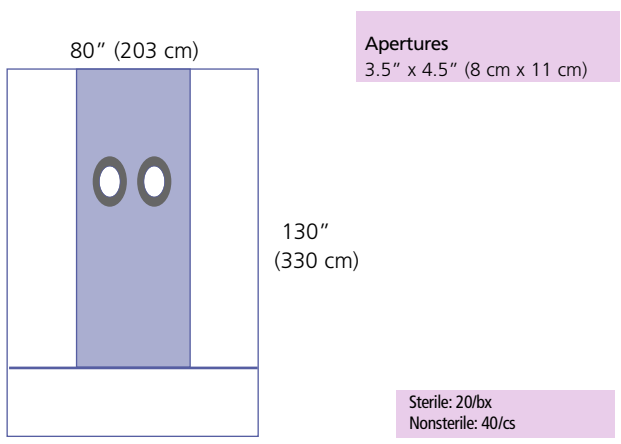

ANGIO-Shield® Absorbent Angio Sheet D2265C

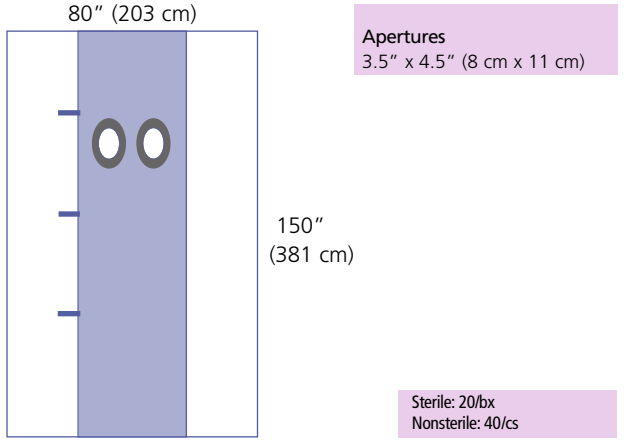



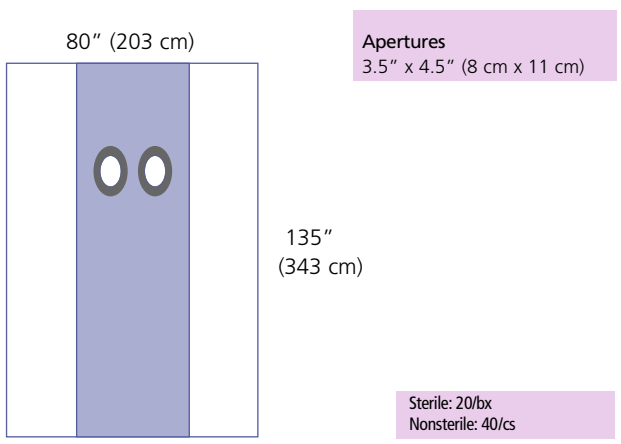

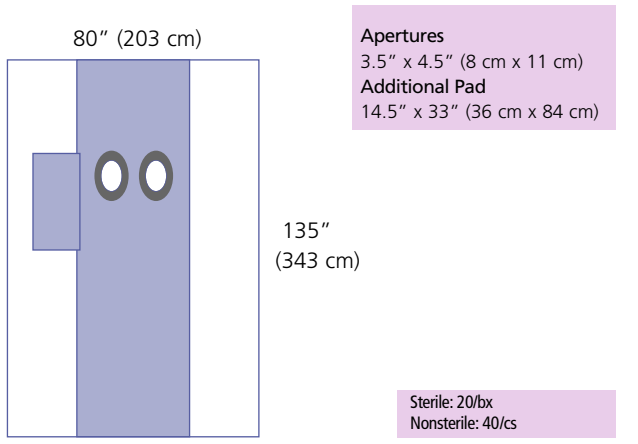

ANGIO-Shield® Absorbent Angio Sheet D2244



ANGIO-Shield® Absorbent Angio Sheet D2286



PRODUCT KEY:  Adhesive  Clear Film  Nonwoven Fabric  Absorbent Reinforcement  Foam  Antimicrobial Adhesive

*NOTE: "C" Product codes require a 4-6 week lead time.

Oval Aperture Angiography Drapes

ANGIO-Shield® Absorbent Angio Sheet D2292C

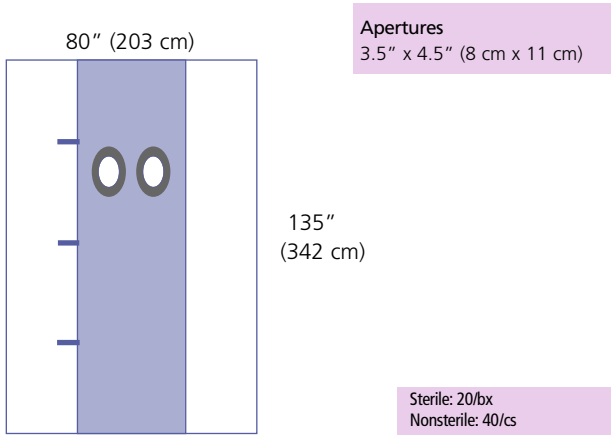

ANGIO-Shield® Absorbent Angio Sheet C2308*

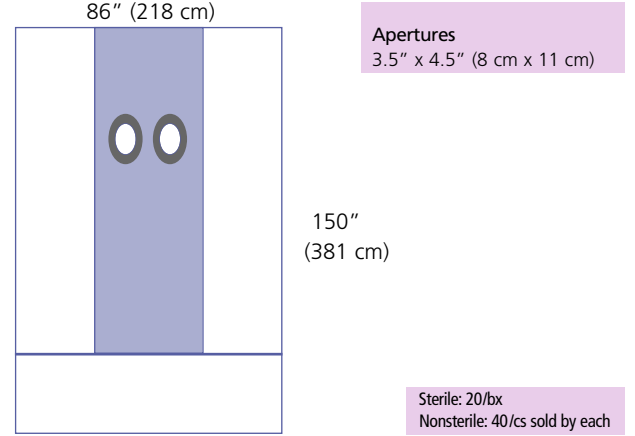

ANGIO-Shield® Absorbent Angio Sheet D2294C

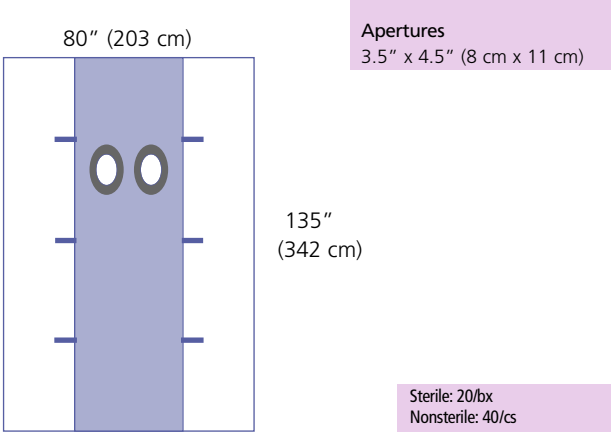

ANGIO-Shield® Absorbent Angio Sheet C2345*

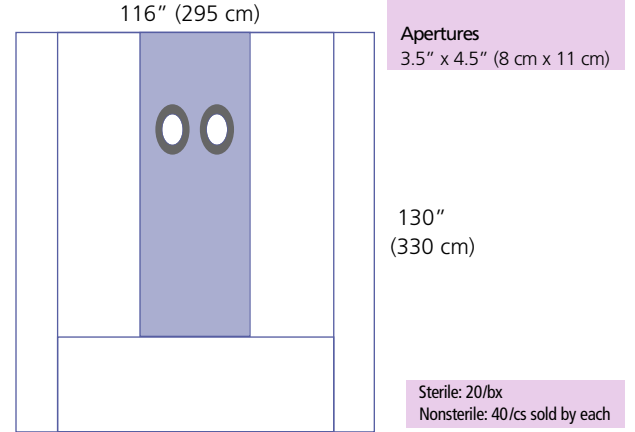

ANGIO-Shield® Absorbent Angio Sheet D2298C

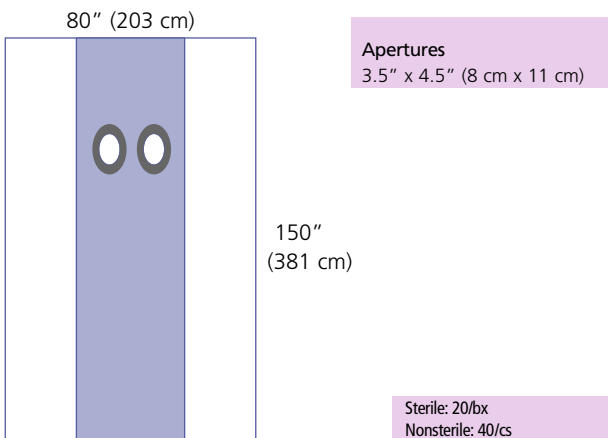

PRODUCT KEY:

- Adhesive
- Clear Film
- Nonwoven Fabric
- Absorbent Reinforcement
- Foam
- Antimicrobial Adhesive

ACTI-Gard® Antimicrobial Pacer Drapes

ACTI-Gard® Antimicrobial Pacer Sheet D6614C

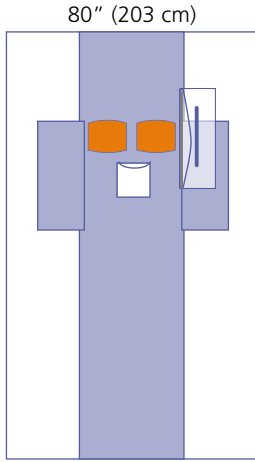

Adhesive Areas
8" x 6" (20 cm x 15 cm)
Pouches
11" x 23" (27 cm x 58 cm)
8.5" x 10" (21 cm x 25 cm)
Additional Pads (2)
14.5" x 33" (36 cm x 84 cm)

150"
(381 cm)

Sterile: 20/bx
Nonsterile: 30/cs

ACTI-Gard® Antimicrobial Fluoroscope Procedure Sheet D6625C

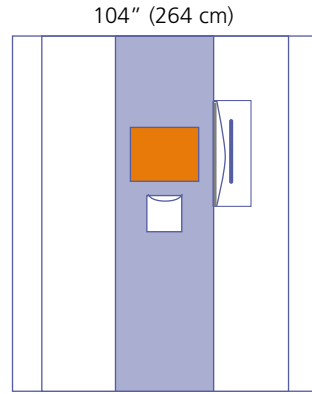

Adhesive Area
17" x 13" (43 cm x 33 cm)
Pouches
11" x 23" (27 cm x 58 cm)
8.5" x 10" (21 cm x 25 cm)

110"
(279 cm)

Sterile: 20/bx
Nonsterile: 30/cs

ACTI-Gard® Antimicrobial Fluoroscope Procedure Sheet D6621

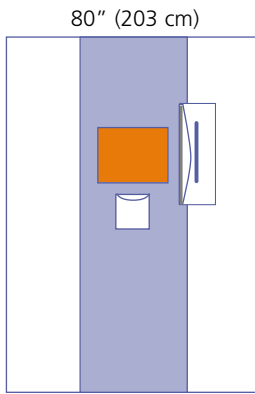

Adhesive Area
17" x 13" (43 cm x 33 cm)
Pouches
11" x 23" (27 cm x 58 cm)
8.5" x 10" (21 cm x 25 cm)

110"
(279 cm)

Sterile: 20/bx
Nonsterile: 30/cs

ACTI-Gard® Antimicrobial Fluoroscope Procedure Sheet D6628C

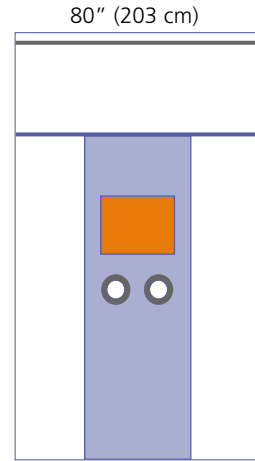

Adhesive Area
17" x 13" (43 cm x 33 cm)
Adhesive Strip
1" x 80" (2.5 cm x 203 cm)
Apertures
3.5" Dia. (8 cm Dia.)

150"
(381 cm)

Sterile: 20/bx
Nonsterile: 30/cs

ACTI-Gard® Antimicrobial Pacer Sheet D6622

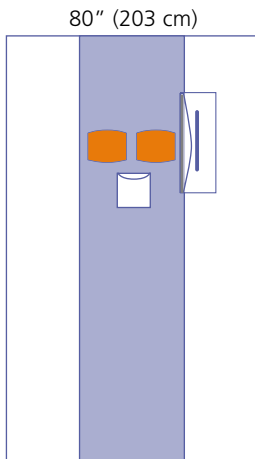

Adhesive Areas
8" x 6" (20 cm x 15 cm)
Pouches
11" x 23" (27 cm x 58 cm)
8.5" x 10" (21 cm x 25 cm)

150"
(381 cm)

Sterile: 20/bx
Nonsterile: 40/cs

ACTI-Gard® Antimicrobial Fluoroscope Procedure Sheet D6643C

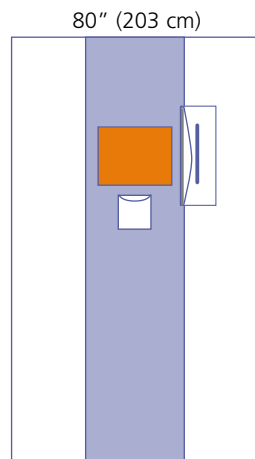

Adhesive Area
17" x 13" (43 cm x 33 cm)
Pouches
11" x 23" (27 cm x 58 cm)
8.5" x 10" (21 cm x 25 cm)

158"
(401 cm)

PRODUCT KEY:

-  Adhesive
-  Clear Film
-  Nonwoven Fabric
-  Absorbent Reinforcement
-  Foam
-  Antimicrobial Adhesive

*NOTE: "C" Product codes require a 4-6 week lead time.

ACTI-Gard® Antimicrobial Pacer Drapes

Pacer Drapes

ACTI-Gard® Antimicrobial Pacer Sheet D6662

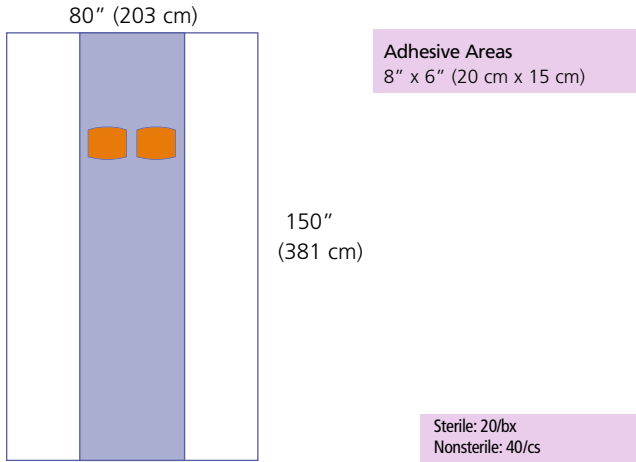

Fluoroscope Procedure Sheet D2221

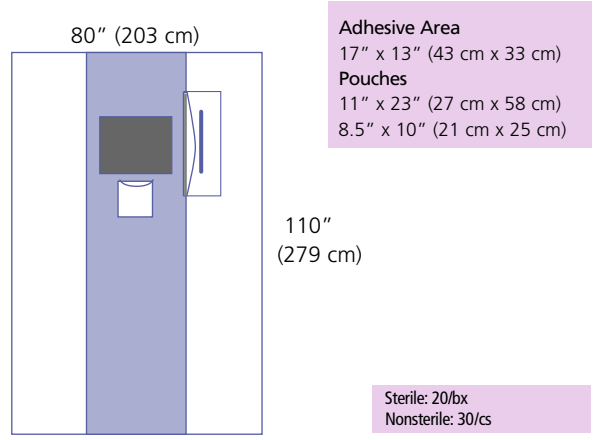

ACTI-Gard® Antimicrobial Fluoroscope Procedure Sheet D6663

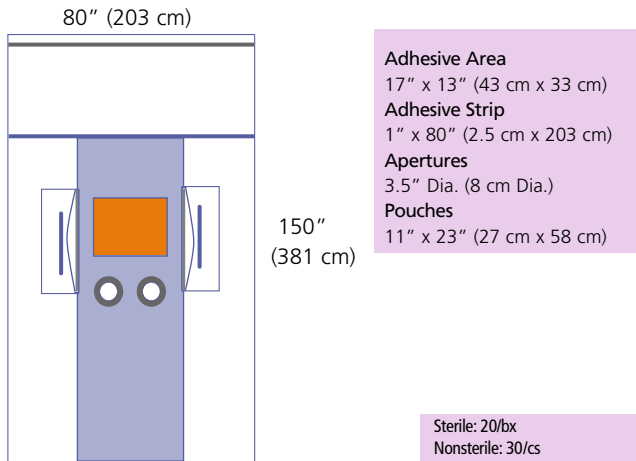

Pacemaker Sheet D2310C



ACTI-Gard® Antimicrobial Fluoroscope Procedure Sheet D6673C

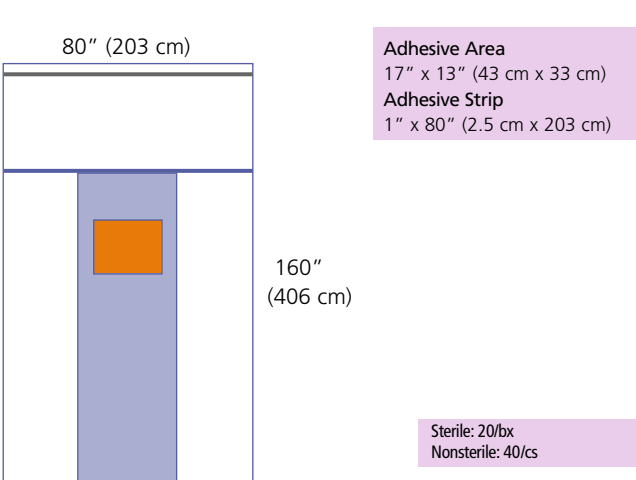

Pacemaker Sheet C2304*

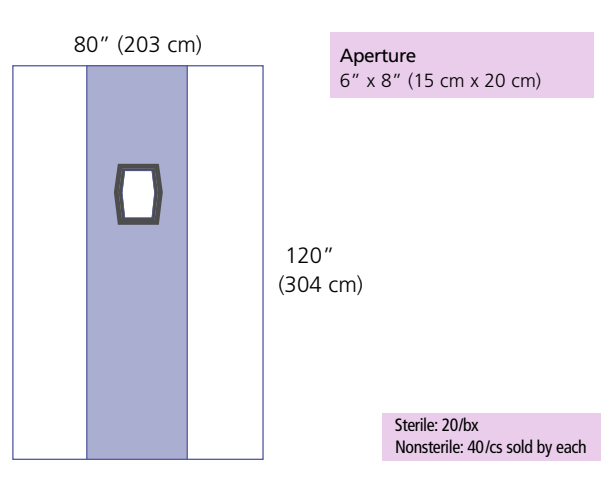

PRODUCT KEY: Adhesive Clear Film Nonwoven Fabric Absorbent Reinforcement Foam Antimicrobial Adhesive



Pacer Drapes

Fluoroscope Procedure Sheet

C2311*

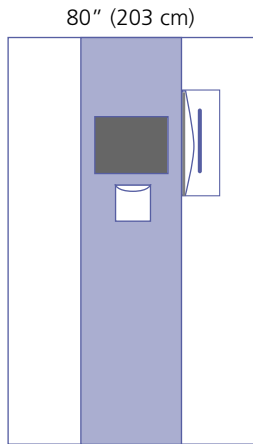

Adhesive Area
17" x 13" (43 cm x 33 cm)
Pouches
11" x 23" (27 cm x 58 cm)
8.5" x 10" (21 cm x 25 cm)

Sterile: 20/bx
Nonsterile: 30/cs sold by each

Pacemaker Sheet

C2335*

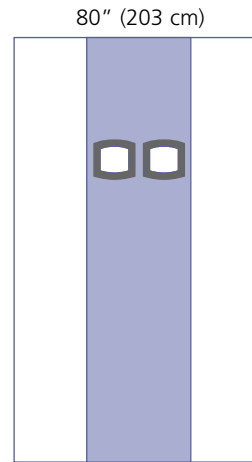

Apertures
6" x 4" (15 cm x 20 cm)

Sterile: 20/bx
Nonsterile: 30/cs sold by each

Pacemaker Sheet

C2319*

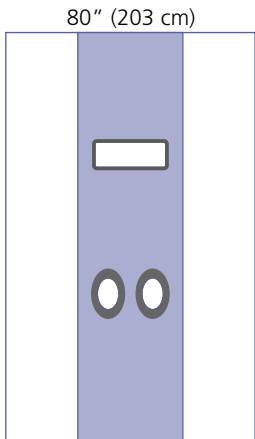

Rectangular Aperture
16" x 6" (41 cm x 15 cm)
Oval Apertures
3.5" x 4.5" (9 cm x 11 cm)

Sterile: 20/bx
Nonsterile: 30/cs sold by each

Pacemaker Sheet

C2325*

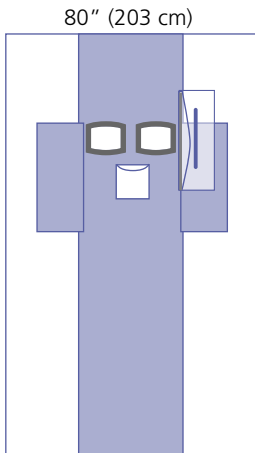

Apertures
8" x 6" (20 cm x 15 cm)
Pouches
11" x 23" (27 cm x 58 cm)
8.5" x 10" (21 cm x 25 cm)
Additional Pads (2)
14.5" x 33" (36 cm x 84 cm)

Sterile: 20/bx
Nonsterile: 30/cs sold by each

PRODUCT KEY:



Adhesive



Clear Film



Nonwoven Fabric

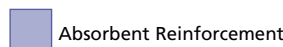

Absorbent Reinforcement



Foam

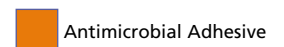

Antimicrobial Adhesive

*NOTE: "C" Product codes require a 4-6 week lead time.

Single Aperture Drapes

ANGIO-Shield® Special Procedure Drape D2224

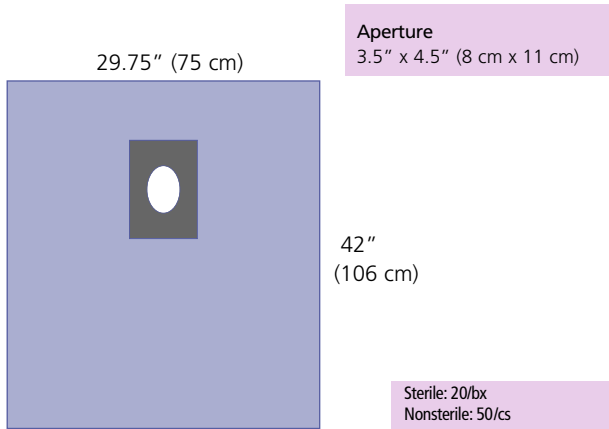

Teen Absorbent Angio Sheet C2242*

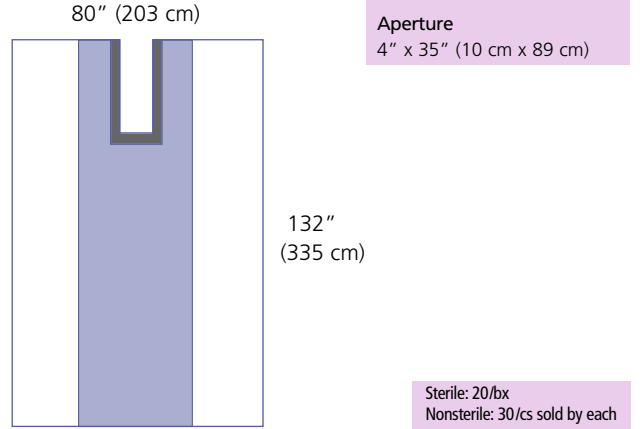

Fistula Drape D2264

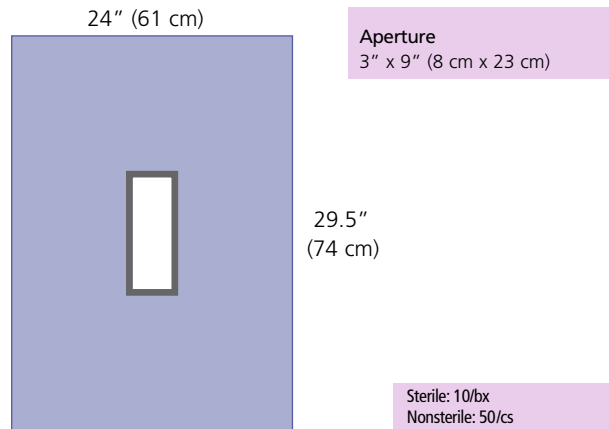

Special Procedure Drape C2289*

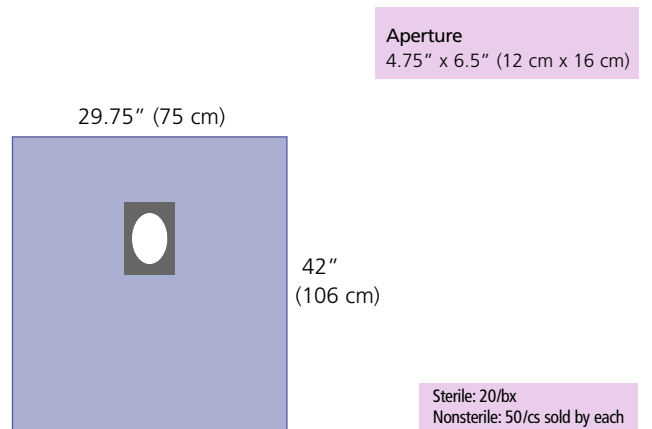

Full Body Fistula Sheet D2318C

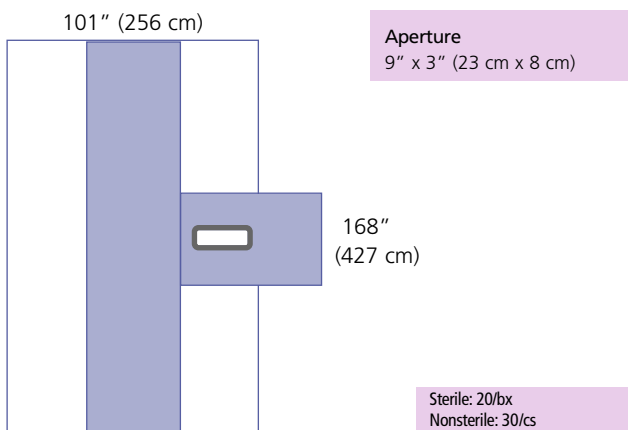

Fistula Drape C2290*

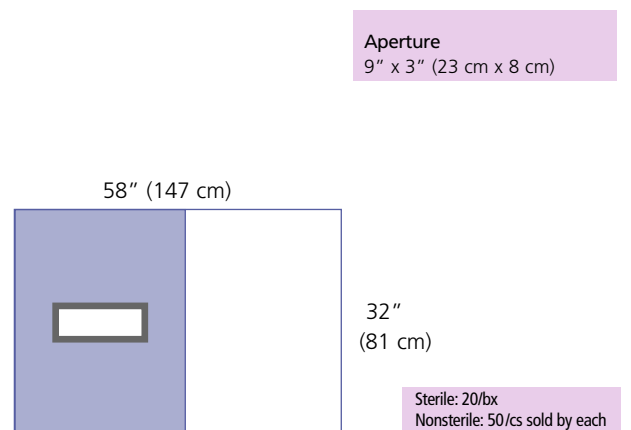

PRODUCT KEY: Adhesive Clear Film Nonwoven Fabric Absorbent Reinforcement Foam Antimicrobial Adhesive

Single Aperture Drapes

Subclavian/Jugular/Biliary Drapes

Small Aperture Drape

C2299*

Aperture
5" Dia. (13 cm Dia.)

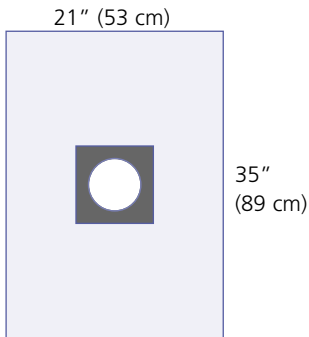

Sterile: 20/bx
Nonsterile: 100/cs sold by each

Subclavian Drape

D2260

Apertures
8.5" x 10" (22 cm x 25 cm)

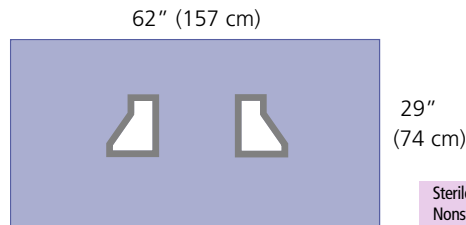

Sterile: 20/bx
Nonsterile: 50/cs

Jugular Sheet

D2315C

Apertures
6" x 8" (15 cm x 20 cm)

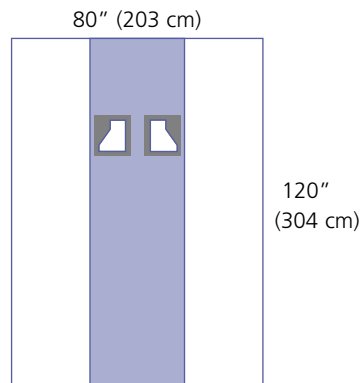

Sterile: 20/bx
Nonsterile: 30/cs

Jugular Sheet

C2332*

Apertures
6" x 9" (15 cm x 23 cm)

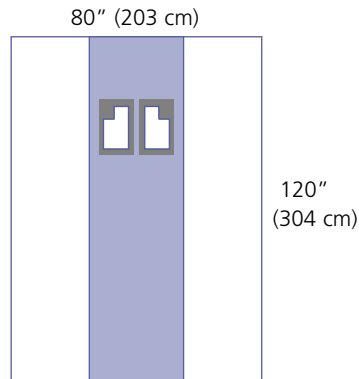

Sterile: 20/bx
Nonsterile: 30/cs sold by each

PRODUCT KEY:

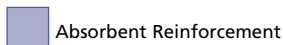

*NOTE: "C" Product codes require a 4-6 week lead time.

Subclavian/Jugular/Biliary Drapes

Subclavian/Biliary Sheet

C2349*

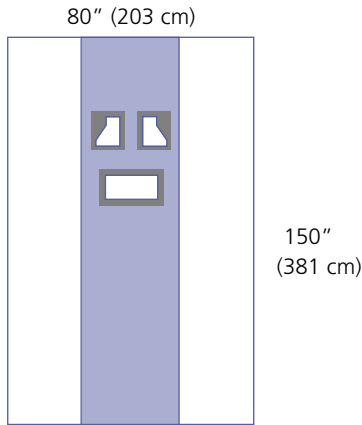

Apertures
6" x 8" (15 cm x 20 cm)
Biliary Aperture
12" x 8" (30 cm x 20 cm)

Sterile: 20/bx
Nonsterile: 30/cs sold by each

Central Line Drapes

Central Line Sheet

D2317C

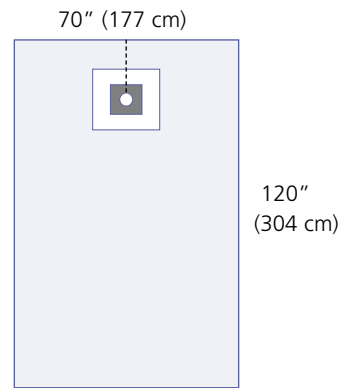

Aperture
4" Dia. (10 cm Dia.)
Perforated fenestration slit for easy removal

Sterile: 20/bx
Nonsterile: 50/cs

PICC Line Sheet

D2342

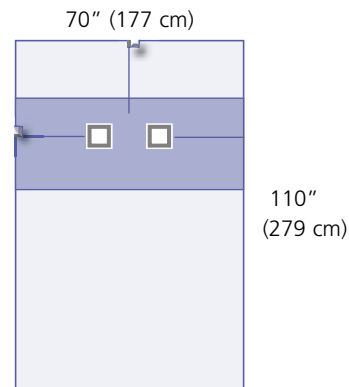

Apertures
6" x 5" (15 cm x 13 cm)
Absorbent Pad
70" x 29.25" (178 cm x 74 cm)
Resealable perforations at top, left and right sides

Sterile: 20/bx
Nonsterile: 40/cs

Central Line Drape

C2324*

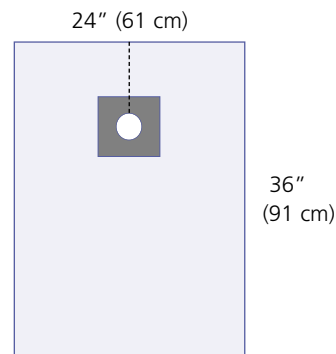

Aperture
4" Dia. (10 cm Dia.)
Perforated fenestration slit for easy removal

Sterile: 30/bx
Nonsterile: 100/cs sold by each

PRODUCT KEY:

- Adhesive
- Clear Film
- Nonwoven Fabric
- Absorbent Reinforcement
- Foam
- Antimicrobial Adhesive

Central Line Drapes

Accessories

Central Line Sheet C2346*

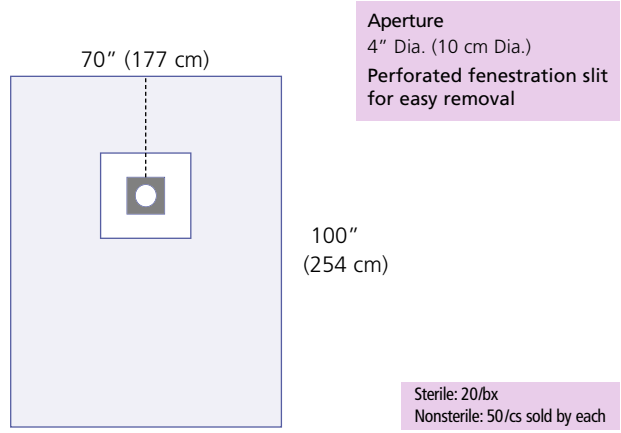

Fluoroscope Cover D1012

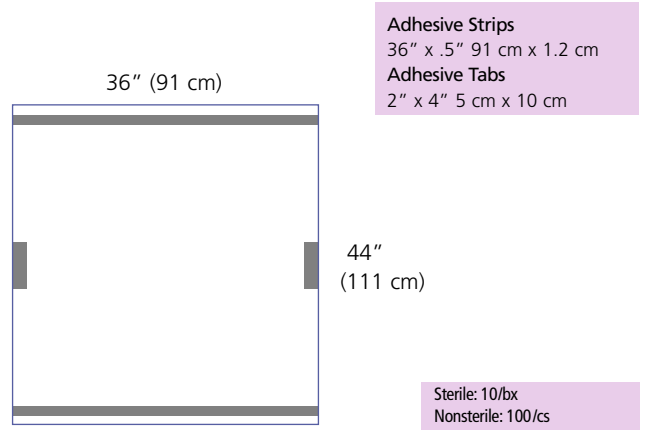

PICC Line Drape C2351*

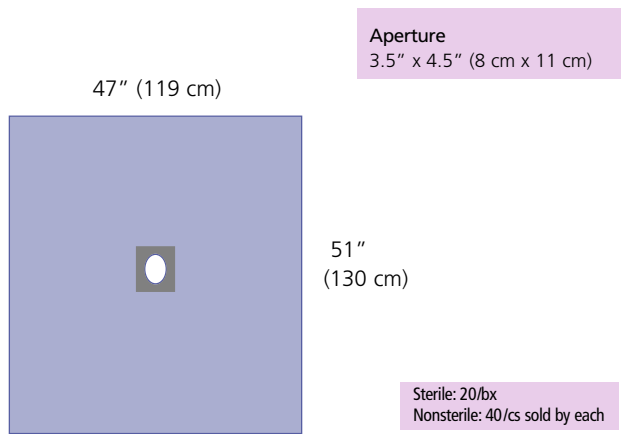



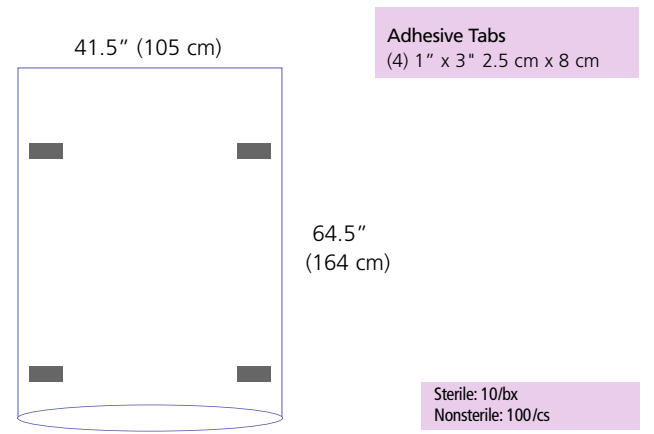

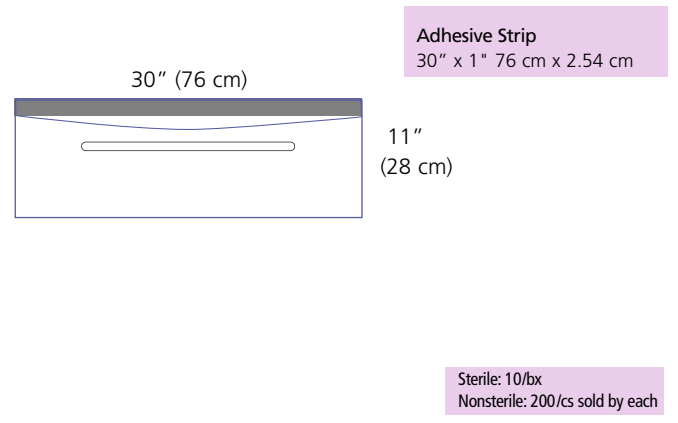

C-Arm Cover D1013



Irrigation Pouch C2326*



PRODUCT KEY:  Adhesive  Clear Film  Nonwoven Fabric  Absorbent Reinforcement  Foam  Antimicrobial Adhesive

*NOTE: "C" Product codes require a 4-6 week lead time.

Numerical Index

Product Code	Page	Product Code	Page
D1012/D1012NS	13	D2317C/D2317NSC	12
D1013/D1013NS	13	D2318C/D2318NSC	10
D1093/D1093NS	4	C2319/C2319NS*	9
D1191/D1191NS	4	C2324/C2324NS*	12
D1195/D1195NS	4	C2325/C2325NS*	9
D1295/D1295NS	5	C2326/C2326NS*	13
D1391/D1391NS	5	C2332/C2332NS*	11
D1395/D1395NS	3	C2335/C2335NS*	9
D1495/D1495NS	3	C2339/C2339NS*	4
D1595/D1595NS	3	D2342/D2342NS	12
D2221/D2221NS	8	D2344/D2344NS	1
D2224/D2224NS	9	C2345/C2345NS*	6
D2244/D2244NS	5	C2346/C2346NS*	13
C2242/C2242NS*	10	C2349/C2349NS*	12
D2252/D2252NS	5	C2351/C2351NS*	13
D2260/D2260NS	11	D2355/D2355NS	1
D2264/D2264NS	10	D2366/D2366NS	1
D2265C/D2265NSC	5	C2377/C2377NS*	1
D2284C/D2284NSC	3	D2388/D2388NS	1
D2286/D2286NS	5	D2399/D2399NS	1
D2288C/D2288NSC	3	C2411/C2411NS	2
C2289/C2289NS*	10	D2422/D2422NS	2
C2290/C2290NS*	10	C2433/C2433NS*	2
D2292C/D2292NSC	6	C2444/C2444NS*	2
D2294C/D2294NSC	6	D6614C/D6614NSC	7
D2298C/D2298NSC	6	D6621/D6621NS	7
C2299/C2299NS*	11	D6622/D6622NS	7
C2302/C2302NS*	3	D6625C/D6625NSC	7
C2304/C2304NS*	8	D6628C/D6628NSC	7
C2308/C2308NS*	6	D6643C/D6643NSC	7
D2310C/D2310NSC	8	D6663/D6663NS	8
C2311/C2311NS*	9	D6673C/D6673NSC	8
D2315C/D2315NSC	11		

*NOTE: "C" Product codes require a 4-6 week lead time.

All MCD
Products are
Made in USA



MCD's Authorized Representative
for CE Marked Products:
Scanlan Group B.V.
Postbus 75664, 1118 ZS Schiphol-Tripport, The Netherlands
Tel +31-(0)20-653 0553 Fax +31-(0)20-653 3053

2010 Medical Concepts Development
2500 Ventura Drive St. Paul MN 55125
Tel 800.345.0644 Fax 651.735.7197
www.medconceptsdev.com

© 2010 Medical Concepts Development Inc. The information contained herein is subject to change without notice. MCD shall not be liable for technical or editorial errors or omissions contained herein.

AX-91 Rev D